

TRITEC

ENERGY FOR
A BETTER WORLD

TRI-STAND ASSEMBLY INSTRUCTIONS

Trapezoidal sheet roof

- 
- simple
 - quick
 - efficient

Installing the mounting system in 4 easy steps:

- Measuring and predrilling the module field
- Riveting the SafeClick onto the trapezoidal sheet
- Inserting the TS insertion profiles into the SafeClick
- Inserting the modules into the TS insertion profile

www.tritec-energy.com

TRI-STAND ASSEMBLY INSTRUCTIONS

TRITEC

Trapezoidal sheet roof

INSERTION SYSTEM TRAPEZOIDAL SHEET ROOF

The installation is divided into 4 easy steps:

1. Measuring the bottom SafeClick row and predrilling the complete module field
2. Riveting the SafeClicks
3. Attaching the TS insertion profiles
4. Inserting the modules



INSTALLING THE MOUNTING SYSTEM

Preparation: Adjusting the drilling gauge to the trapezoidal sheet and the module size

In order to protect the roof and the drilling gauge from damage during installation, the rubber rings on the upper crossbar of the drilling gauge are adjusted to rest on a raised bead.

Here, the guides of the drilling jig support must be symmetrically adjusted to the upper drill sleeve so that a space of 2 to 5 mm remains between trapezoidal sheet and drilling jig.

The right-hand drill sleeve is to be adjusted such that it is provided centred above the raised bead of the trapezoidal sheet. The lower drill sleeve is adjusted to the module insertion length + 10.5 mm to the upper drill sleeve.

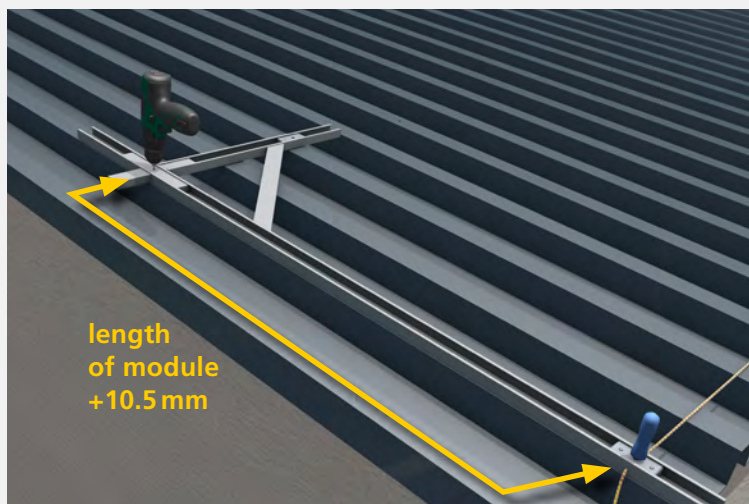

Tools

Installation requires the following tools:



01 Cordless electric drill with a 6.5 mm drill bit

02 Cordless riveting machine with special 17/42 BT nosepiece

03 Allen key 3 mm

04 TRI-STAND bending tool

05 TRI-VENT drilling gauge

TRI-STAND ASSEMBLY INSTRUCTIONS

TRITEC

Trapezoidal sheet roof

1 Measuring the bottom SafeClick row and predrilling the complete module field

After the substructure of the roof has been checked for its point bearing capacity, the module field is measured on the roof as dimensioned by the TRI-DESIGN software. The first and last SafeClick of the bottom row is then marked as in the dimensioning plan.

In a first step, the first SafeClick of the bottom row is predrilled at the point specified in the dimensioning using a diameter of 6.5 mm. The drilling gauge can be rotated 180° for easier handling. The last SafeClick of the bottom row is predrilled along the same lines.

Important:

Always use the drilling gauge to drill the holes to prevent slipping of the drill.

To mark the bottom SafeClick row, a piece of string is drawn from the first to the last drilled hole. The raised beads required can now be marked along the string. The number of raised beads ensues from the dimensioning plan and depends on the roof load, the thickness of the trapezoidal sheet and the distance of the raised beads.

The drilling gauge is now placed onto the marking and the SafeClick predrilled using the drill sleeve. For this, the drilling gauge can be rotated 180° for optimal positioning on the raised bead.

The locating pin is inserted into the bottom drill sleeve of the drilling gauge and into the predrilled hole of the bottom SafeClick row. The trapezoidal sheet is then predrilled using the upper locating sleeves and a drill with a diameter of 6.5 mm. The drilling gauge with the locating pin is subsequently re-set into the drill hole above it.

Unless all raised beads are drilled, the drill holes should be offset. In each row a SafeClick is attached both to the first and the last raised bead.

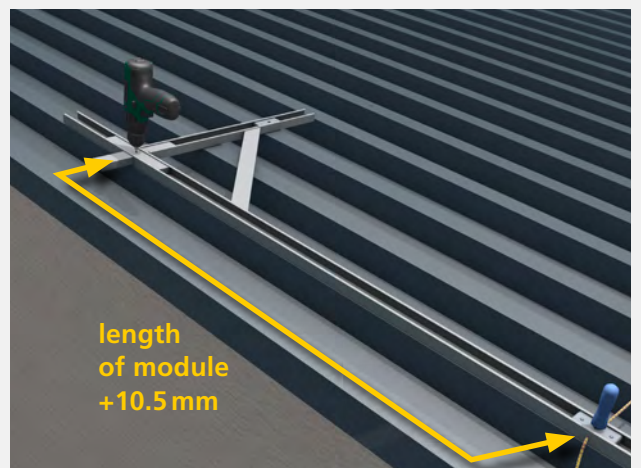
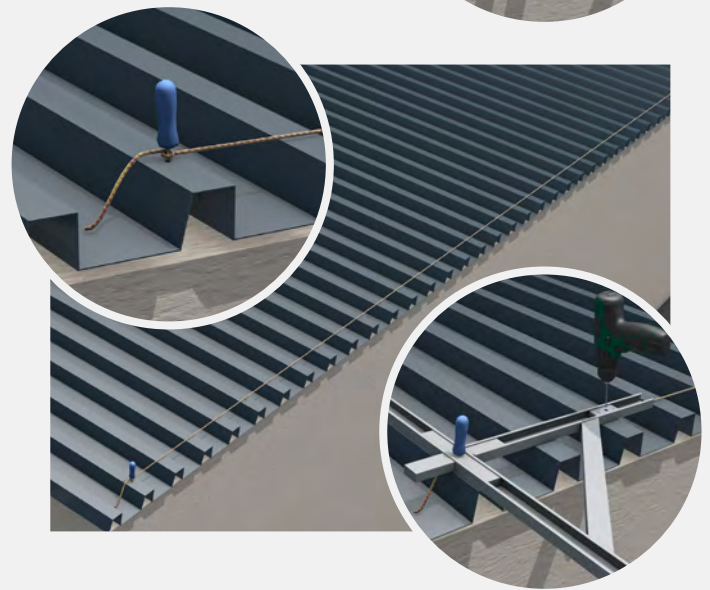
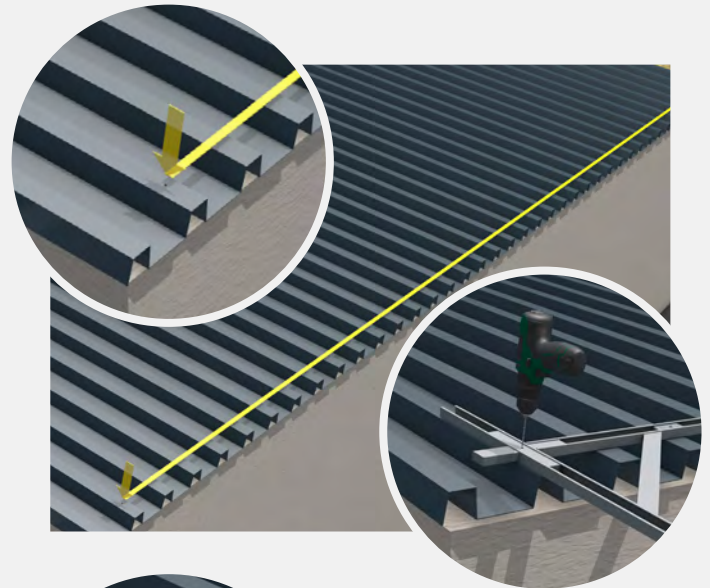

TRI-STAND ASSEMBLY INSTRUCTIONS

TRITEC

Trapezoidal sheet roof

2 Riveting the SafeClicks

The prepared SafeClicks are now placed into the predrilled holes on the roof. The leaf spring must face up. The rivet can then be driven using a cordless riveting machine.

Attention:

Use a 17/42 BT nosepiece for the TRI-STAND sealing rivets.

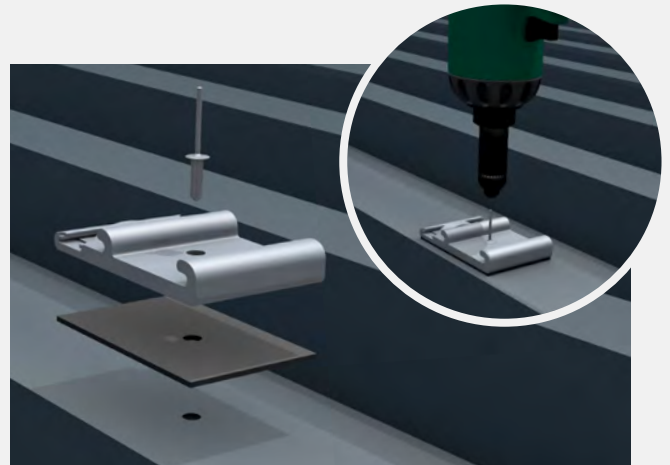

3 Attaching the TS insertion profiles

When all SafeClicks are riveted, the TS insertion profiles can be clicked into place from the top.

For systems wider than 6 m, the TS insertion profiles are connected by using TS-C connectors. The TS-C connector is inserted into a mounted TS insertion profile with the screw facing down until the connector is flush with the TS insertion profile. The next TS insertion profile is then attached to the previous one leaving a 3 mm gap. The TS-C connector is pushed into the new TS insertion profile up to its centre marking and then fixed with a screw. This connection allows the TS insertion profiles to expand in heat and contract in cold with relatively little stress while still transferring the module loads.

To allow the rails to expand, leave a gap of at least 3 mm between the TS insertion profiles. The screws of the TS-C connectors also need to face down and should only be screwed on one side. Using the TS bending tool, each TS insertion profile is now bent on the left and right of a SafeClick in the centre of the rail. This secures the rail against shifting as a result of heat or cold.

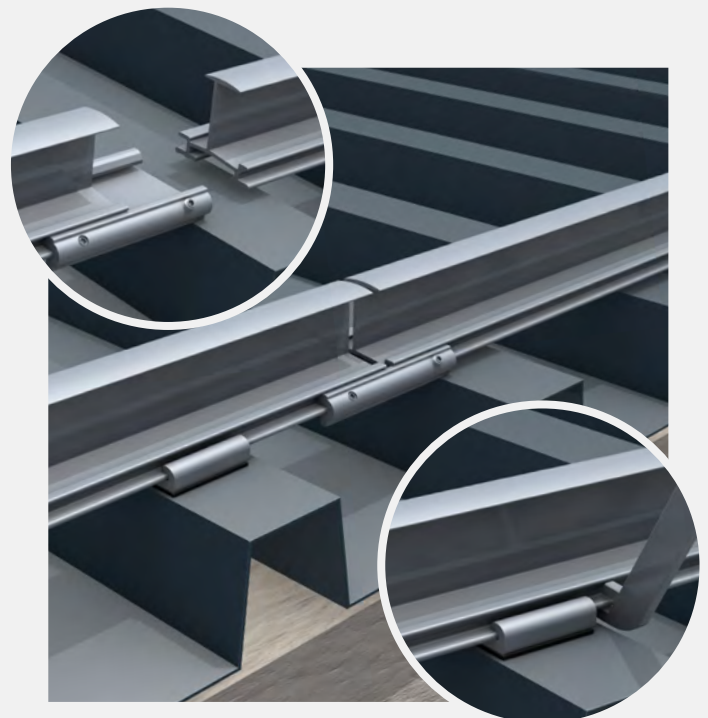

TRI-STAND ASSEMBLY INSTRUCTIONS

TRITEC

Trapezoidal sheet roof

4 Inserting the modules

Once the TS rails have been attached, the modules can be inserted into the installation system in 3 steps.

First, the modules are inserted into the top TS insertion profile and then deposited on the bottom profile. They are then inserted into the bottom profile. The modules are now held in place by gravity and are securely fixed without screws. To secure the edge modules, TS-E end brackets are attached to the end of each module row.

Tip:

When a TS insertion profile ends on a trapezoidal high pitch, the screw of the end angle is difficult to access. Therefore, the end angles can be attached to the TS insertion profile before it is installed.

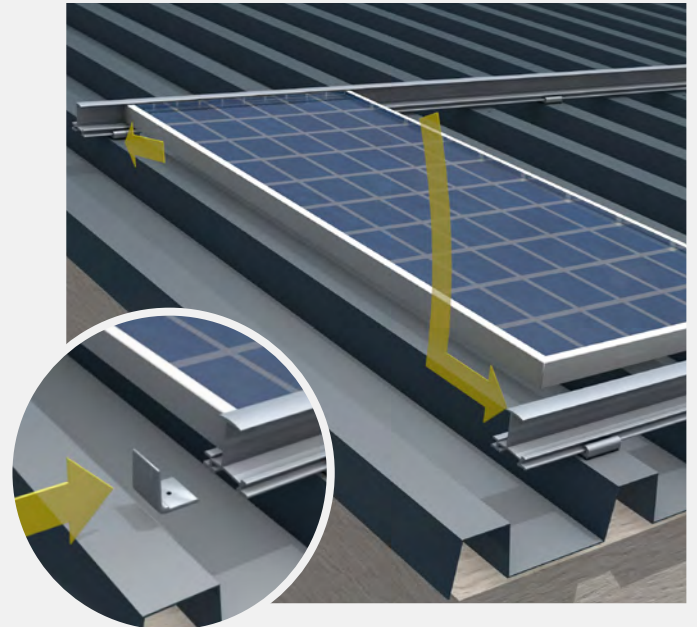

USE OF THE TRI-STAND BENDING TOOL

The TS insertion profiles must each be edge-bent per profile left and right of a SafeClick located in the centre of the TS rail. This method will limit the movement of profiles as a result of temperature.

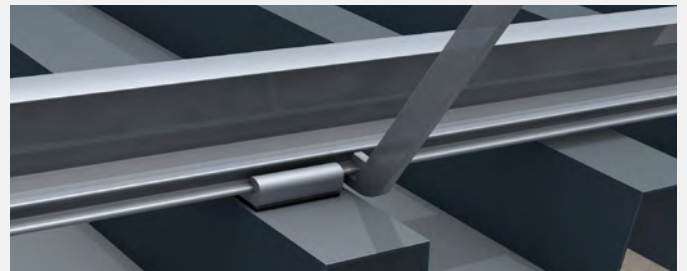

Fix TS insertion profile in place

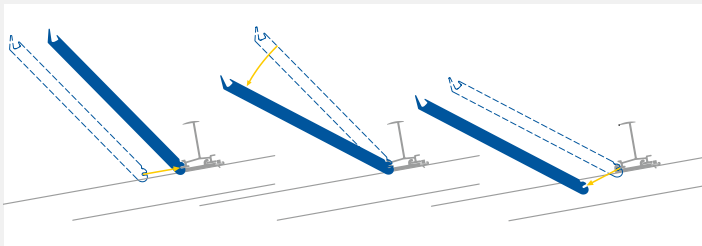

Push bending tool next to the center SafeClick of the rail into the lower leg of the TS insertion profile.

Turn the bending tool by 8 – 10 cm toward the bottom.

Pull out the bending tool again and repeat the same steps on the other side of the SafeClick.

Detaching the TS insertion profile from SafeClick

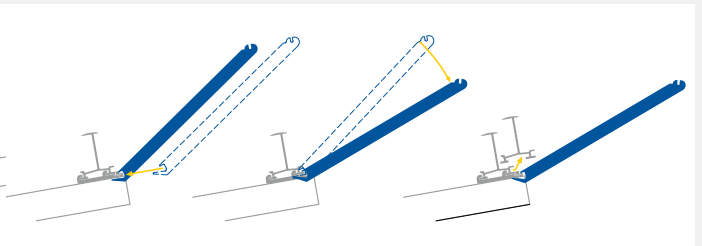

Push bending tool from the top over the flat spring of the SafeClick.

Turn the bending tool toward the bottom all the way to the stop.

Push TS insertion profile toward the top and remove.

TRI-STAND ASSEMBLY INSTRUCTIONS

TRITEC

Trapezoidal sheet roof



Find here the detailed assembly video.

Just scan the QR Code or visit the following link:

https://www.youtube.com/watch?v=E5pDkcurGa4&feature=emb_rel_pause



Find here the training video for the TRI-DESIGN planning software.

Just scan the QR Code or visit the following link:

<https://www.tritec-energy.com/en/trainings/>

The optimal mounting solution for every roof

TRITEC mounting systems combine over 30 years of photovoltaic experience. The own products TRI-STAND and TRI-ROOF+ offer the ideal mounting solution for a wide range of roof types and alignments.

We attach great importance to the high-quality processing of the components as well as to the durability of the substructure.

Further information and the download of the assembly instructions you will find on our homepage www.tritec-energy.com.

Or just talk to us directly. Our experts are at your disposal to answer all your questions.

TRIENERGY Schweiz AG

Im Klosteracker 35, CH – 4103 Bottmingen

P +41 61 264 00 20

E info@tritec-energy.com

W www.tritec-energy.com