



PROTOTYPE DECLARATION / Prototypenbescheinigung

Product prototype certificate number

No. 2623/0083-PTCER

For the company: / Für das Unternehmen

Shenzhen SOFARSOLAR Co., Ltd.

11/F., Gaoxingqi Technology Building, No.67 Area, Xingdong Community, Xin'an Sub-district, Bao'an District, Shenzhen City, Guangdong Province, P.R. China

Has provided to E&E Product Certification Body of SGS the technical documentation indicated in both articles no. 12 of standards /

Hat der E&E-Produktzertifizierungsstelle von SGS die technischen Dokumente für beide Artikel-Nr. 12 des Standards überliefert:

- **VDE-AR-N 4110: 2018.** Technical requirements for the connection and operation of customer installations to the medium voltage network (TAR medium voltage) / *VDE-AR-N 4110: 2018. Technische Voraussetzungen für den Anschluss und Betrieb von Kundenanlagen an das Mittelspannungsnetz (TAR-Mittelspannung).*

For the product / Für das Produkt: **Type 2 PV inverter / PV-Wechselrichter Typ 2**

Models / Modelle:		SOFAR 100KTLX-G4 / SOFAR 110KTLX-G4 / SOFAR 125KTLX-G4 / SOFAR 125KTLX-G4-A
Technical Data / Technische Daten:		
DC	Max. input voltage / Max.-Eingangsspannung:	See Annex 3 / siehe Anhang 3
	MPPT Voltage Range / MPPT-Spannungsbereich:	See Annex 3 / siehe Anhang 3
	No. of MPP inputs per tracker / Anzahl der MPP-Eingänge pro Tracker	See Annex 3 / siehe Anhang 3
	Max. input current / Max.-Eingangsstrom:	See Annex 3 / siehe Anhang 3
AC	AC output power/ AC-Ausgangsleistung:	See Annex 3 / siehe Anhang 3
	Max. AC output current / Max. AC-Ausgangsstrom:	See Annex 3 / siehe Anhang 3
	Nominal Grid Voltage / Nominale Netzspannung:	See Annex 3 / siehe Anhang 3
	Nominal Grid Frequency / Nominale Netzfrequenz:	See Annex 3 / siehe Anhang 3

We confirm that the above mentioned PV inverters are considered as Prototypes in accordance with the VDE-AR-N 4110 and the standard FGW TR 8 / *Hiermit bestätigen wir, dass es sich bei der genannten EZE nach VDE-AR-N 4110 und FGW TR 8 um einen Prototyp handelt*

- **FGW TR8. Certification of the Electrical Characteristics of Power Generating Units, Systems and Storage Systems as well as for their Components to the Grid. Revision 9.**
FGW TR8. Zertifizierung der elektrischen Eigenschaften von Erzeugungseinheiten und -anlagen, Speicher sowie für deren Komponenten am Stromnetz. Revision 9.

Test reports and certificates will be issued when the testing process is finished and evaluated with positive result. *Testberichte und Zertifikate werden nach Abschluss des Testprozesses ausgestellt und mit positivem Ergebnis bewertet.*

Restrictions or deviations / *Einschränkungen und Abweichungen:*

A connecting terminal plate has to be installed separately if necessary / *Eine Prüfklemmleiste ist bei Bedarf separat nachzurüsten.*

Brussels, 24th of February 2023

Calogero Lana
Certification Manager /
Zertifizierungsmanager

Annex 1 / Anhang 1

This certificate confirms that the mentioned generation unit is a prototype according to FGW TR 8. For this purpose, the PGU is described below and the main technical developments or innovations are presented: /

Diese Bescheinigung bestätigt, dass es sich bei der genannten Erzeugungseinheit nach FGW TR 8 um einen Prototypen handelt. Dazu wird im Folgenden die EZE beschrieben und die wesentlichen technischen Weiterentwicklungen oder Neuerungen dargestellt:

Description of the generating unit / Beschreibung der Erzeugungseinheit:

modules from solar radiation into the public alternating current grid using power electronics. /

Die Photovoltaikerzeugungseinheit (PV-EZE) ermöglicht die Einspeisung von Gleichstrom erzeugt mittels Photovoltaikmodulen aus solarer Einstrahlung in das öffentliche Wechselstromnetz unter Verwendung von Leistungselektronik.

Treatment according to FGW TR 8, 2.3.2.2 / Behandlung nach FGW TR 8, 2.3.2.2:

The mentioned PGU is a non-wind generation unit. The plant certificate must be issued two years after the commissioning of the first PGU at the latest. /

Bei der genannten EZE handelt es sich um eine Nicht-Wind-Erzeugungseinheit. Spätestens zwei Jahre nach der Inbetriebnahme der ersten EZE muss das Anlagenzertifikat erstellt werden.

The PGU is operated in an PGS (generation plant), which consists of an PGU with PGU certificate and prototypes (case 2). Manufacturer's data must be compiled and provided for certification of the plant. The final plant certificate is issued when the PGU certificate is available for the generation unit in question. /

Die EZE wird in einer EZA (Erzeugungsanlage) betrieben, welche aus EZE mit EZE-Zertifikat und Prototypen besteht (Fall 2). Herstellerangaben müssen erstellt und für die Zertifizierung der Anlage zur Verfügung gestellt werden. Das endgültige Anlagenzertifikat wird erstellt, wenn das EZE-Zertifikat für die genannte Erzeugungseinheit vorliegt.

0 1 2 3 4 5

CEBEC

Annex 2 / Anhang 2

This certificate confirms that the mentioned generation unit is a prototype according to FGW TR 8. For this purpose, the PGU is described below and the main technical developments or innovations are presented: /

Diese Bescheinigung bestätigt, dass die genannte Erzeugungseinheit (EZE) in der Lage ist, die Anforderungen an die elektrischen Eigenschaften der Erzeugungseinheit nach VDE-AR-N 4110 zu erfüllen. Dazu wird im Folgenden die Übereinstimmung der elektrischen Eigenschaften der EZE mit den Anforderungen nach VDE-ARN 4110 nachgewiesen:

VDE-AR-N 4110	Comment and reference / Kommentar und Bewertung
<p>12 Regulation for prototypes / Prototypen-Regelung</p>	
<p>A prototype is the first power generating unit of a type presenting substantial technological developments or innovations and all other power generating units of this type put into operation within two years after the commissioning of the first power generating unit of this type. / <i>Ein Prototyp ist die erste Erzeugungseinheit eines Typs, der wesentliche technische Weiterentwicklungen oder Neuerungen aufweist, und alle weiteren Erzeugungseinheiten dieses Typs, die innerhalb von zwei Jahren nach der Inbetriebsetzung der ersten Erzeugungseinheit dieses Typs in Betrieb gesetzt werden.</i></p> <p>NOTE 1 This definition corresponds to the term's definition given in SDLWindV. There is no relation to the term "pilot wind turbine" (de: Pilotwindenergieanlage) used in the EEG. / <i>ANMERKUNG 1 Diese Definition entspricht der Begriffsdefinition nach SDLWindV. Es besteht kein Zusammenhang zum Begriff „Pilotwindenergieanlage“ im EEG [6].</i></p> <p>Technological developments and innovations are generally considered to be substantial where components or software versions are changed so that the electrical behaviour of the power generating unit at the network changes significantly and a unit certification of this new type is required. / <i>Wesentliche technische Weiterentwicklungen und Neuerungen liegen in der Regel vor, wenn Komponenten oder Softwareversionen so geändert werden, dass sich das elektrische Verhalten der Erzeugungseinheit am Netz signifikant ändert und eine Einheitenzertifizierung dieses neuen Typs erforderlich wird.</i></p>	<p>Checked / Berücksichtigt:</p> <ul style="list-style-type: none"> - See annex 1 / siehe Anhang 1
<p>For the prototype of a power generating unit the requirements of this VDE application guide apply. For these prototypes, a prototype confirmation, in which the certification body confirms a substantial technological development or innovation based on a manufacturer declaration, is sufficient, instead of the unit certificate, for a period of two years after commissioning of the first power generating unit prototype in Germany. The certification body shall also check and set out reproducibly in the prototype confirmation, whether the prototype is generally capable of meeting the requirements of this VDE application guide for the electrical properties of the power generating unit. This is based on an electrical properties data sheet prepared by the manufacturer of the power generating unit. / <i>Für einen Prototypen einer Erzeugungseinheit gelten die Anforderungen dieser VDE-Anwendungsregel. Innerhalb von zwei Jahren nach der Inbetriebsetzung der ersten Prototypen-Erzeugungseinheit in Deutschland ist für diese Prototypen anstelle des Einheitenzertifikats eine Prototypenbestätigung ausreichend, in der die Zertifizierungsstelle das Vorhandensein einer wesentlichen technischen Weiterentwicklung oder Neuerung auf Basis einer Herstellererklärung bestätigt. Weiterhin ist durch die Zertifizierungsstelle zu prüfen und in der Prototypenbestätigung nachvollziehbar auszuweisen, ob der Prototyp grundsätzlich in der Lage ist, die Anforderungen dieser VDE-Anwendungsregel an die elektrischen Eigenschaften der Erzeugungseinheit zu erfüllen. Dies erfolgt auf Basis eines vom Hersteller der Erzeugungseinheit erstellten Datenblattes der elektrischen Eigenschaften.</i></p> <p>For prototypes commissioned before 2019-04-27, the above-mentioned period starts 2019-04-27. / <i>Für Prototypen die vor dem 27.04.2019 in Betrieb gesetzt werden, beginnt die oben genannte Frist am 27.04.2019.</i></p>	<p>Checked / Berücksichtigt</p>

VDE-AR-N 4110	Comment and reference / Kommentar und Bewertung
<p>In order to allow the certification body to carry out the required plausibility test, the data sheet of the power generating unit shall contain at least the following information:/ <i>Damit die geforderte Plausibilitätsprüfung durch die Zertifizierungsstelle erfolgen kann, muss das Datenblatt der Erzeugungseinheit mindestens folgende Angaben enthalten:</i></p>	<p>Checked / <i>Berücksichtigt</i> After documentation provided by the manufacturer (see annex 3 and Annex 4). / <i>Daten vom Hersteller stehen zur Verfügung (siehe Anhang 3 und Anhang 4).</i></p>
<p>1. Electrical data (nominal and rated quantities) / <i>Elektrische Daten (Nenn- und Bemessungsgrößen);</i></p>	<p>Compliant / <i>Erfüllt:</i> - See annex 3 / <i>siehe Anhang 3</i></p>
<p>2. Schematic overview circuit diagram of the power generating unit with all relevant componentsschematisches / <i>Übersichtsbilcl der Erzeugungseinheit mit allen wesentlichen Komponenten.</i></p>	<p>Compliant / <i>Erfüllt:</i> - See annex 4 / <i>siehe Anhang 4</i></p>
<p>3. Operating ranges of the power generating unit / <i>Betriebsbereiche der Erzeugungseinheit:</i></p> <ul style="list-style-type: none"> • Limits in quasi-static operation / <i>Grenzen im quasistationären Betrieb.</i> • Reactive power adjustment range / <i>Blindleistungsstellbereich.</i> • FRT limit curve (U/t diagram) / <i>FRT-Grenzkurve(U/t-Diagramm).</i> 	<p>Compliant / <i>Erfüllt:</i> - See annex 4 / <i>siehe Anhang 4</i></p>
<p>4. Protection functions with setting ranges / <i>Schutzfunktionen mit Einstellberemhen:</i></p> <ul style="list-style-type: none"> • Decoupling protection / <i>Entkupplungsschutz.</i> • Self-protection / <i>Eigenschutz.</i> 	<p>Compliant / <i>Erfüllt:</i> - See annex 4 / <i>siehe Anhang 4</i></p> <p>Restriction / <i>Einschränkung:</i> A connecting terminal plate has to be installed separately if necessary / <i>Eine Prüfklemmleiste ist bei Bedarf separat nachzurüsten.</i></p>
<p>5. Active power control / <i>Wirkleistungsregelung:</i></p> <ul style="list-style-type: none"> • Power/frequency behaviour / <i>Leistungs-Freqbenz-Verhalten.</i> • Active power gradient / <i>Wirkleistungsgradient.</i> 	<p>Compliant / <i>Erfüllt:</i> - See annex 4 / <i>siehe Anhang 4</i></p>
<p>6. Reactive power control / <i>Blindleistungsregelung.</i></p>	<p>Compliant / <i>Erfüllt:</i> - See annex 4 / <i>siehe Anhang 4</i></p>
<p>7. Dynamic reactive current feed-in / <i>Dynamische Blindstromeinspeisung:</i></p> <ul style="list-style-type: none"> • Basic functionality / <i>Grundsätzliche Funktionsweise.</i> 	<p>Compliant / <i>Erfüllt:</i> - See annex 4 / <i>siehe Anhang 4</i></p>
<p>8. Declaration of the manufacturer stating that the power generating unit has been designed so that the requirements of this application guide for the power generating unit can be complied with / <i>Erklärung des Herstellers, dass die Erzeugungseinheit so konstruiert wurde, dass die Anforderungen dieser Anwendungsregel an die Erzeugungseinheit erfüllt werden können.</i></p>	<p>Compliant / <i>Erfüllt:</i> - See annex 4 / <i>siehe Anhang 4</i></p>
<p>At the latest after expiry of the above-mentioned period, a unit certificate is required. / <i>Spätestens nach Ablauf der oben genannten Frist ist ein Einheitenzertifikat erforderlich.</i></p> <p><i>NOTE 2 If the unit certificate is available prior to expiry of the two-year term after commissioning the first power generating unit of this type, it can still be a prototype. /</i> <i>ANMERKUNG 2 Sofern das Einheitenzertifikat vor Ablauf der Frist von zwei Jahren nach der Inbetriebsetzung der ersten Erzeugungseinheit.</i></p>	<p>Compliant / <i>Erfüllt</i></p>

Annex 3 / Anhang 3

Datasheet of the generating unit / Datenblatt der Erzeugungseinheit:

Models	SOFAR 100KTLX-G4	SOFAR 110KTLX-G4	SOFAR 125KTLX-G4	SOFAR 125KTLX-G4-A
PV Input (DC)				
Recommended Max. PV input	150000Wp	165000Wp	190000Wp	190000Wp
Number of MPP trackers	10			
Number of DC inputs	2 for each MPPT			
Max. PV input voltage (Vdc)	1100			
Min. PV input voltage /	200			
Rated input voltage (Vdc)	625V	625V	625V	625V
MPPT operating voltage range	180~1000			
Full power MPPT voltage range	500~850V	500~850V	500~850V	500~850V
Max. input MPPT current	10*40A	10*40A	10*40A	10*40A
Max. DC short-circuit current (A)	10*50A	10*50A	10*50A	10*50A
Output (AC)				
Rated power	100000W	100000W	110000W	125000W
Max. AC power	100000VA	110000VA	125000VA	125000VA
Rated output current	145A	145A	159.5A	181.2A
Max. output current	145A	159.5A	181.2A	181.2A
Rated AC voltage (V)	3/N/PE 230/400Vac			
AC voltage range	310Vac-480Vac (According to local standard)			
Rated frequency	50/60Hz			
Grid frequency range	45Hz-55Hz/55Hz-65Hz (According to local standard)			
Active power adjustable range	0~100%			
THDi	< 1%			
DC current injection	< 0.5% In			
Power factor	1 (adjustable+/-0.8)			
Efficiency				
Max. efficiency / European efficiency	98.6%/ 98.3%			
Protection				
DC reverse polarity protection	Yes			
Anti-islanding protection	Yes			
Leakage current protection	Yes			
Anti reverse power function	Yes			
Ground fault monitoring	Yes			
PV-array string fault monitoring	Yes			
DC switch	Yes			
Anti-PID function / PID Recovery	Yes			
DC arc detection / AFCI	Yes			

Input/ output SPD	PV:Type II standard; AC:Type II standard
General Data	
Dimensions (W*H*D, mm)	970*695*325
Weight (kg)	75
Isolation method	Transformerless
Night power consumption	< 2W
Operating ambient temperature range (°C)	-30~60°C (up 45°C derating)
Allowable relative humidity range (non-condensing)	< 95%
Cooling method	Fan
Max. operating altitude (m)	4000
Display	LCD, App via BluetoothAPP
Communication	RS485/Bluetooth, Optional:WiFi/Ethernet

0 1 2 3 4 5



Annex 4 / Anhang 4

Technical data of the generating unit / Technische Daten der Erzeugungseinheit:

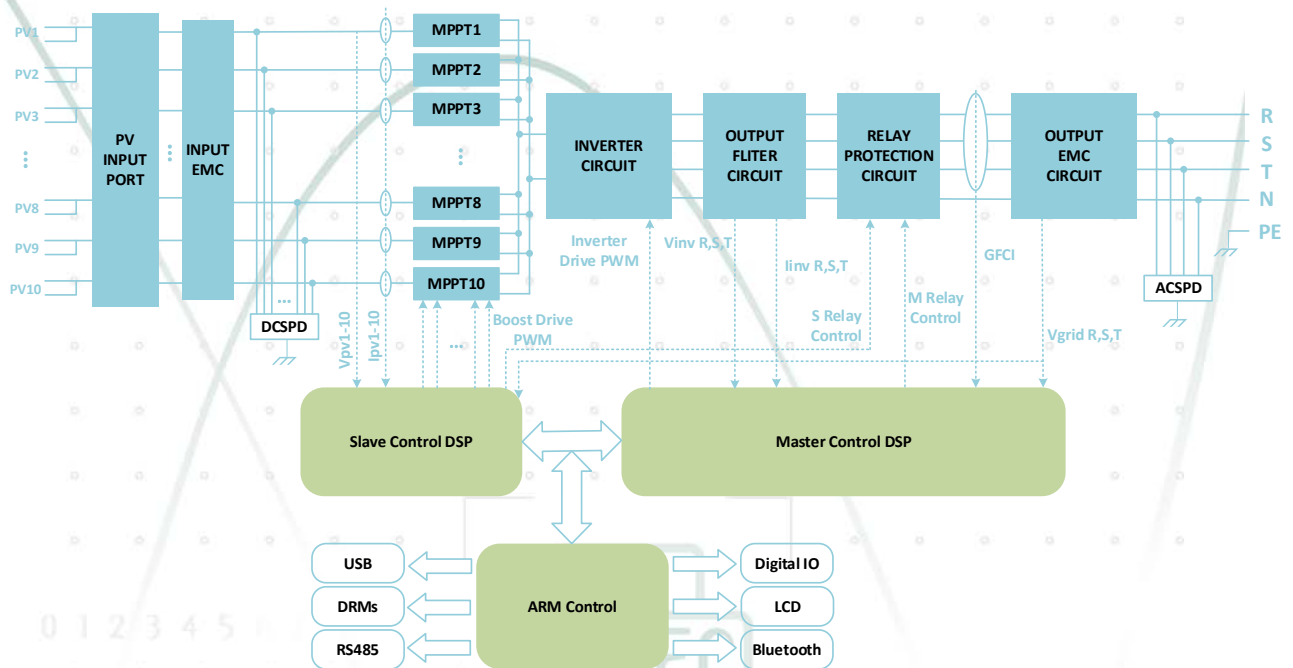

Figure 1

Selection for VDE-AR-N 4110

First start by downloading the safety parameters file (named after the corresponding safety country) on the website and copy the file to a USB flash drive.

Then insert the USB flash drive into PV inverter SOFAR 125KTLX-G4-A. Enter menu "Safety Param." according to Figure 2 below.



Figure 2

Operational areas of MODEL SOFAR 125KTLX-G4-A

a) Limits during quasi-stationary operation

For VDE-AR-N 4110:2018-11, in the entire frequency range from 47.5 Hz to 51.5 Hz and voltages in the range of 85% U_n to 115% U_n at the MODEL SOFAR 125KTLX-G4-A PV inverter AC connection terminal, while voltage gradient $<5\% U_c / \text{min}$ and a frequency gradient of $<0.5\% f_n / \text{min}$, for quasi-stationary operation, MODEL SOFAR 125KTLX-G4-A PV inverter is able to in parallel operation with grid according to the minimum duration time Figure 3 below.

When voltage changes at the inverter AC terminal in the amount of $\Delta U \leq 10\% U_c$ with voltage gradients of $\geq 5\% U_c / \text{min}$ within the voltage band from 90% U_c to 110% U_c occur, inverter has no reduction for active and reactive power and keep connected to the grid.

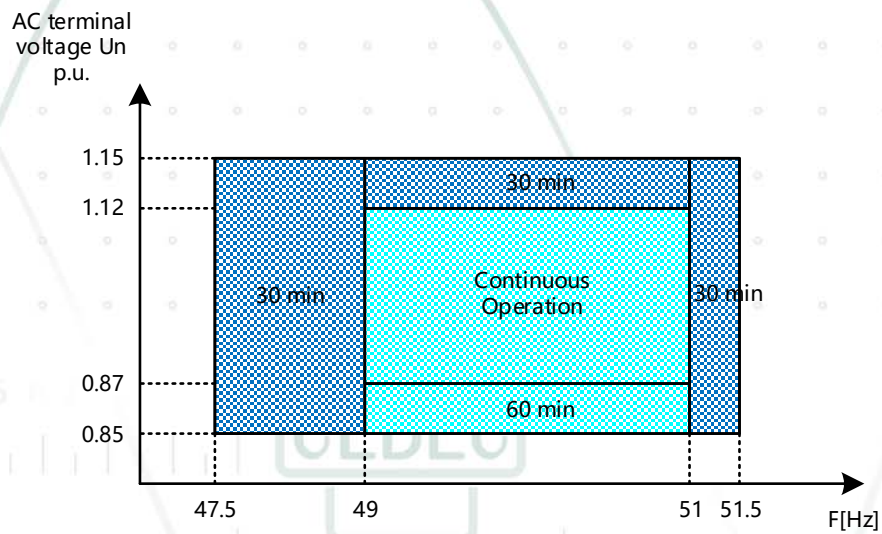

Figure 3 Quasi-stationary operation range for MODEL SOFAR 125KTLX-G4-A

b) Reactive power capability

For VDE-AR-N 4110:2018-11, the reactive power capability of MODEL SOFAR 125KTLX-G4-A PV inverter is according to Figure 4 below.

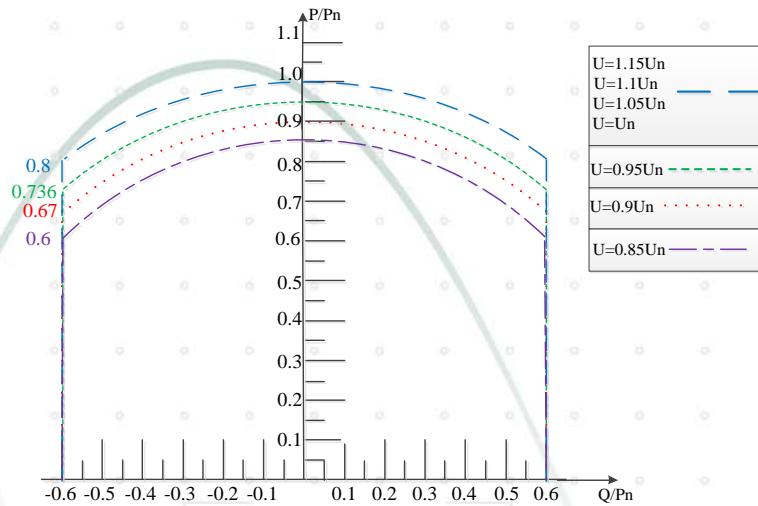

Figure 4 a. Voltage-dependent PQ diagram for MODEL SOFAR 125KTLX-G4-A and SOFAR 100KTLX-G4

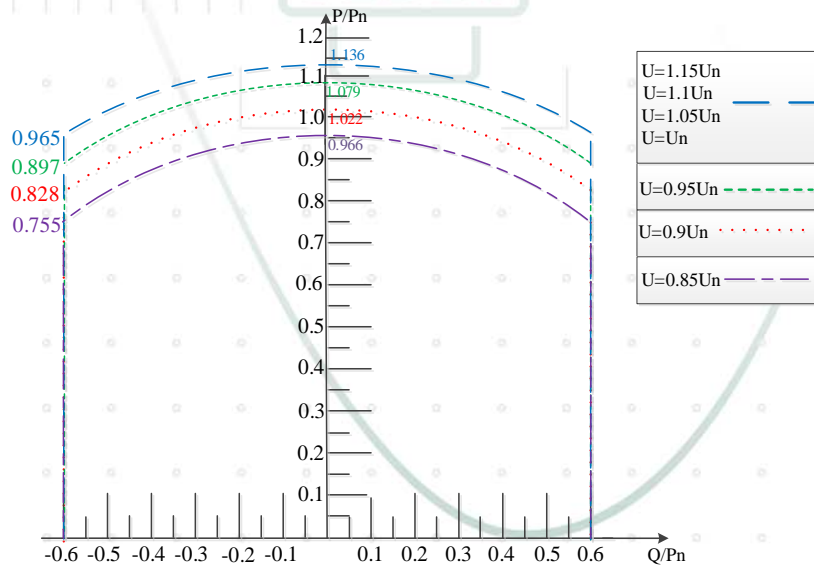

Figure 4. b. Voltage-dependent PQ diagram for MODEL SOFAR 125KTLX-G4

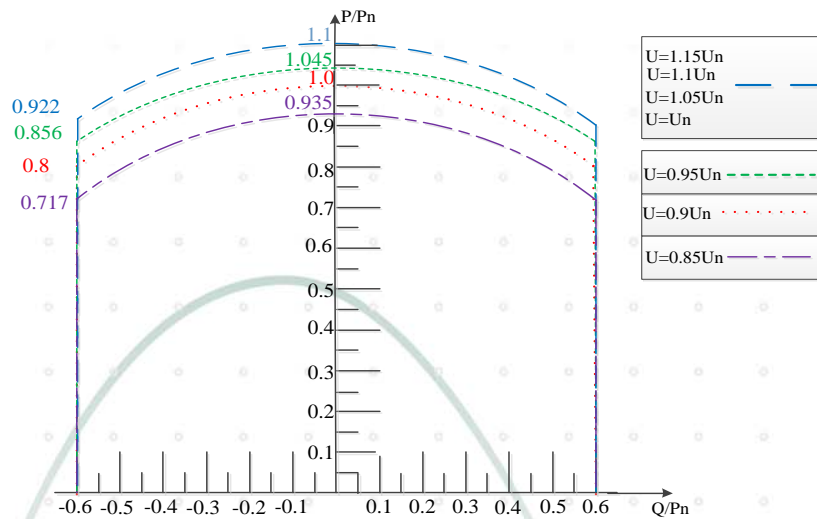

Figure 4.c Voltage-dependent PQ diagram for MODEL SOFAR 110KTLX-G4

c) FRT-limit curve (U(t)-diagram)

For VDE-AR-N 4110:2018-11, the FRT limit curve of MODEL SOFAR 125KTLX-G4-A inverter is according to Figure 5 below.

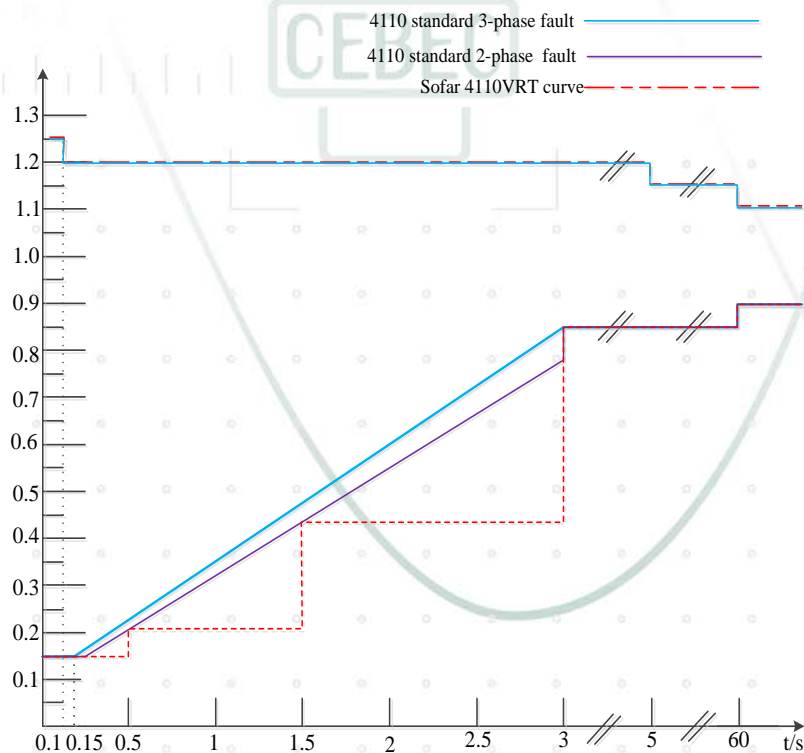

Figure 5 FRT limit curve for SOFAR 125KTLX-G4-A

Note: For the reason of limited dynamic grid support requirement, MODEL SOFAR 125KTLX-G4-A PV provide ZP(Zero Power) mode as well, when select this mode, MODEL SOFAR 125KTLX-G4-A PV will supply no active and reactive power during LVRT for the voltage drop $\leq 70\%U_n$, but for voltage range from $70\% \sim 90\%U_n$, even choose ZP mode, inverter will enter into normal LVRT period with reactive power supplied by K factor.

0 1 2 3 4 5



Protection functions:

a) Grid protection

The default grid protection of MODEL SOFAR 125KTLX-G4-A for VDE-AR-N 4110:2018-11:2018 is according to Table 1 below:

Function	Protection value	Trip time
U>	Default: 287.5V Range: 230.0-299.0V	Default: 0.10s Range: 0-600s
U>>	Default: 287.5V Range: 230.0-299.0V	Default: 0.10s Range: 0-600s
U<	Default: 184.0V Range: 23.0-230.0V	Default: 1.00 s Range: 0-600s
U<<	Default: 103.5V Range: 23.0-230.0V	Default: 0.30s Range: 0-600s
f>>	Default: 52.5 Hz Range: 50.1-55.0Hz	Default: 0.10s Range: 0-600s
f>	Default: 51.5 Hz Range: 50.1-55.0Hz	Default: 0.20s Range: 0-600s
f<	Default: 47.5 Hz Range: 45.0-49.9Hz	Default: 0.10s Range: 0-600s

Table 1 MODEL SOFAR 125KTLX-G4-A default protection setting for VDE-AR-N 4110:2018-11:2018

Function	Protection value	Trip time
Step for Voltage protection	0.1V	0.01s
Step for Frequency protection	0.1Hz	0.01s

Table 2 MODEL SOFAR 125KTLX-G4-A setting step for voltage/frequency protection

The protection functions is independence from other set point.

After the inverter trip for protection, when the voltage recovers to at least 82%Un and frequency is between 47.6~51.4Hz, MODEL SOFAR 125KTLX-G4-A has the setting of the delay time of recovery for VDE-AR-N 4110:2018-11, the setting range is from 0 to 30 mins, default setting is 90s.

Notes: MODEL SOFAR 125KTLX-G4-A didn't provide testing terminal for protection test without disconnect the wires, such test terminal would be supplied at the system level on the LV side of MV transformer.

b) Intrinsic ("self") protection

For VDE-AR-N 4110:2018-11, MODEL SOFAR 125KTLX-G4-A is integrated with intrinsic hardware protection only for over voltage, the protection is for hardware protection and is not settable. The protection default setting is 1.38Un for 250us.

Active power control

a) Frequency control (P(f)-diagram)

For VDE-AR-N 4110:2018-11, P(f)-diagram is default according to Figure 6 below.

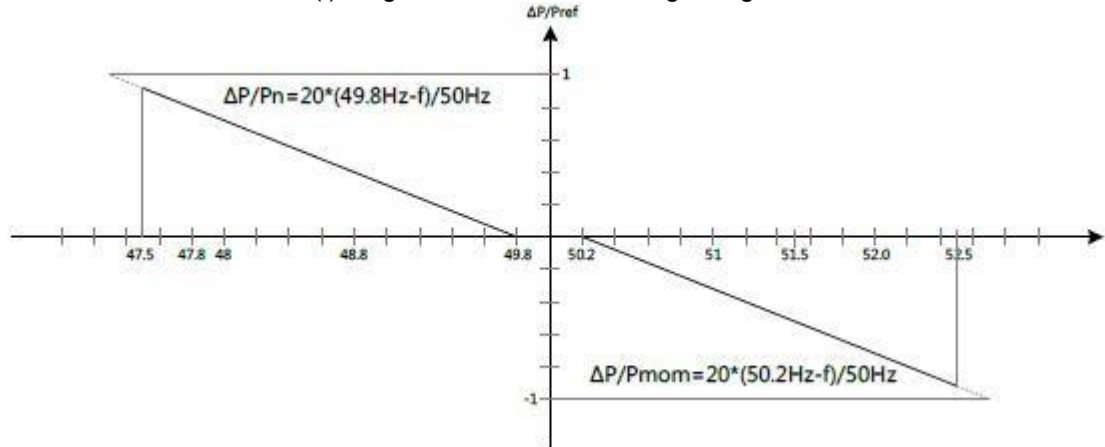

Figure 6 MODEL SOFAR 125KTLX-G4-A P(f)-diagram

Note: Here Pmom is the active power freeze at that moment when the frequency to 50.2Hz. Pn is normal active power. The default gradient for over-frequency and under-frequency is 40%Pref/Hz (slope=5%), while it can be adjustable from 16.67%Pref/Hz(s=12%) to 100%Pref/Hz(s=2%).

When doing for TR3 test, due to the requirement by FGW TR3, inverter take higher priority for active power rising during frequency drop from 49.8Hz to 47.5Hz temporary than dispatching command by grid operator set point only for test purpose, but the final inverter will take higher priority for dispatching command set point.

b) Related gradients, dynamics and functions

For VDE-AR-N 4110:2018-11, the following active power control applied to MODEL SOFAR 125KTLX-G4-A.

Normal active power gradients: 0.33%Pn/s~0.66%Pn/s (default is 0.66%Pn/s) for stationary connection and reconnection after grid fault trip.

P(f)-diagram: When frequency returned to rated value (50Hz±0.2Hz), for the first 10mins, the active power gradients is less than 10%Pn/min, after 10mins quit from abnormal frequency, the active power gradients will back to normal active power gradients: 0.33%Pn/s~0.66%Pn/s.

Dynamic functions: When MODEL SOFAR 125KTLX-G4-A enter into FTR, the active power reduced to zero to ensure reactive power, after the FTR end according to Figure 4 limit or 5s whichever is the earlier, the active power will recover by max ramp rate within 200ms.

c) Set point

For VDE-AR-N 4110:2018-11, the active power control set point applied to MODEL SOFAR 125KTLX-G4-A PV is according to Table 4 Overfrequency derating and underfrequency increment.

Overfrequency derating		
Function	Default Set point	Set range
Frequency-power response(Overfrequency derating)	ON	ON/OFF
Overfrequency Reload Enable	OFF	ON/OFF
Overfrequency Start (0.01Hz step)	50.20Hz	50.10-55.00Hz
Overfrequency Slope	40%Pn/Hz	17-100%Pn/Hz
Overfrequency Reload Start	50.20Hz	50.00-55.00Hz
Overfrequency Reload Delay	0.00s	0-655s
Overfrequency Reload Speed	9%Pn/min	1-6000%Pn/min
underfrequency increment		
Function	Default Set point	Set range
Frequency-power response(Underfrequency derating)	ON	ON/OFF
Underfrequency Reload Enable	OFF	ON/OFF
Underfrequency Start (0.01Hz step)	49.80Hz	45.00-49.98 Hz
Underfrequency Slope	40%Pn/Hz	17-100%Pn/Hz
Underfrequency Reload Start	49.80Hz	45.00-49.98 Hz
Underfrequency Reload Delay	0.00s	0-655s
Underfrequency Reload Speed	9%/min	1-6000%/min

Table 4 Active power set point for MODEL SOFAR 125KTLX-G4-A

Reactive power control

a) Related gradients, dynamics and functions

For VDE-AR-N 4110:2018-11, MODEL SOFAR 125KTLX-G4-A reactive power control is following according to Figure 7 below.

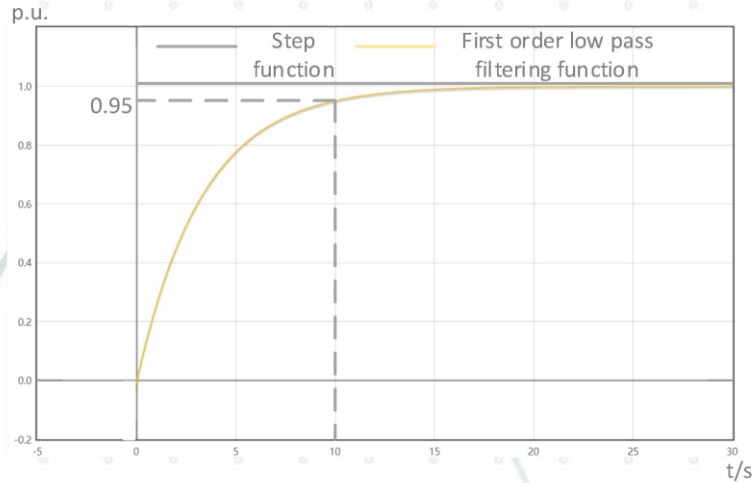

Figure 7 MODEL SOFAR 125KTLX-G4-A reactive power control feature

The reactive power is supplied by equation (1):

$$Q = Q_{set} * [1 - e^{-(t/3\tau)}] \quad (1)$$

Here the time constant 3τ is settable as the time for 95% target value.

For VDE-AR-N 4110:2018-11, the 3τ setting range is from 1~60s, the default setting is 10s.

b) Set point

For VDE-AR-N 4110:2018-11, the reactive power control set point applied to MODEL SOFAR 125KTLX-G4-A is according to Table 6.

Function	Default Set point	Set range
Reactive mode	OFF	Off/Mode1/2/3/4 ⁽¹⁾
Reactive response period	10	1~600s
Mode 1		
Power factor (0.0001)	1.00	-1 ~ -0.8, +0.8~ +1
Mode 2		
Fixed Reactive Percentage (0.01%)	0%	0~60%Pn
Mode 3		
Reactive Cos1 (0.0001)	1.00	-1 ~ -0.8, +0.8~ +1
Reactive dynamic value1	0	-100~100%Pn
Reactive Cos2 (0.0001)	1.00	-1 ~ -0.8, +0.8~ +1
Reactive dynamic value2	0	-100~100%Pn
Reactive Cos3 (0.0001)	1.00	-1 ~ -0.8, +0.8~ +1
Reactive dynamic value3	0	-100~100%Pn
Reactive Cos4 (0.0001)	1.00	-1 ~ -0.8, +0.8~ +1
Reactive dynamic value4	100	-100~100%Pn
Mode 4		
HighVoltStartValue	104	100~130%
HighVoltEndValue	106	100~130%
LowVoltStartValue	96	0~100%
LowVoltEndValue	94	0~100%
MaxLeadingReactivePower	33	0~60%
MaxLaggingReactivePower	33	0~60%
ReactiveResponseWaitTime	0	0~300s
ReactivePowerOffset	0	-100~100%Qmax

Table 6 Reactive power set point for MODEL SOFAR 125KTLX-G4-A

(1) Off The PF is limited to +1.000,s and the “Q-Var limits” is limited to 0.0%.
Mode1: The reactive power can be regulated by the parameter PF (Power Factor).

Mode2: The reactive power can be regulated by the parameter Reactive power limit (in %).

Mode3: Q(P) The PF changes with the output power of the inverter.

Mode4: Q(U) The reactive power changes with the grid voltage.

Dynamic reactive current control

a) Basic functions

The reactive current supply during FRT is calculated by both positive sequence and negative sequence component. The additional reactive current Δi_B of MODEL SOFAR 125KTLX-G4-A is proportional to the voltage deviation Δu ($\Delta i_B = k \cdot \Delta u$), where k is the amplification factor. It is defined by the straight line below in Figure 8.

The k factor is settable between 0 to 10 with the step of 0.1, the default MODEL SOFAR 125KTLX-G4-A k factor for VDE-AR-N 4110:2018-11 is 2.

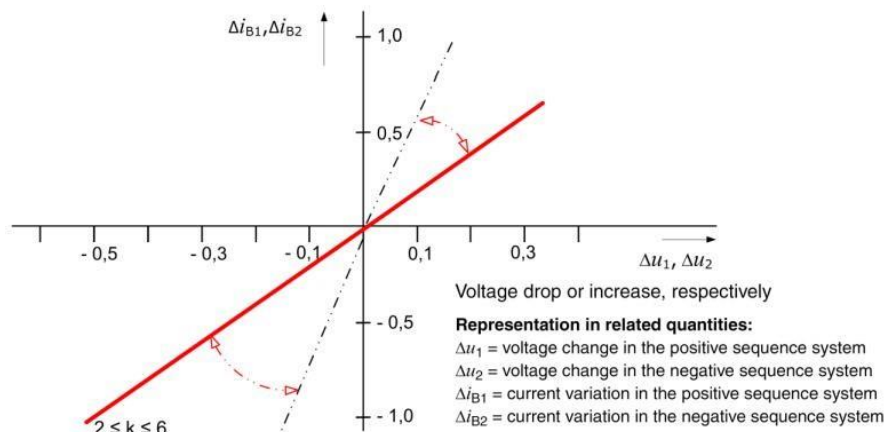

Figure 8 k factor of voltage support in the event of a network fault