

制作说明:

- 1.成品尺寸: 610\*325mm, 不折叠。
- 2.黑白单面打印, 350g白卡纸
- 3.满足Rohs和REACH环保要求

1. Packing List

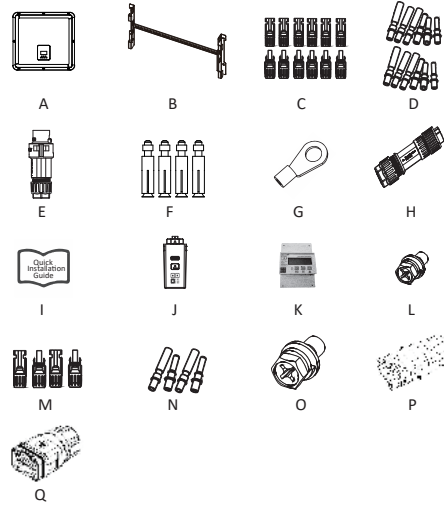

Object	Quantity	Description	Object	Quantity	Description
A	1	Inverter	J	1	WiFi/LAN/GPRS (Optional)
B	1	Bracket	K	1	Meter
C	12	PV connectors (Only for H3-Pro) (6* positive, 5* negative)	L	1	Hexagonal screw M4*16
D	12	PV pin contacts (Only for H3-Pro) (6* positive, 6* negative)	M	4	Battery connectors (2* positive, 2* negative)
E	1	AC connectors-EPS	N	4	Battery pin contacts (2* positive, 2* negative)
F	4	Expansion tubes & Expansion screws	O	1	Hexagonal screw M5*10 grounding screw
G	1	Earth terminal	P	1	COM1-24PIN
H	1	AC connectors-Grid	Q	1	COM2-20PIN
I	1	Quick installation guide			

2. Installation Steps

Please make sure the inverter will be installed with a proper distance as shown below.

Step1: Choose the right location

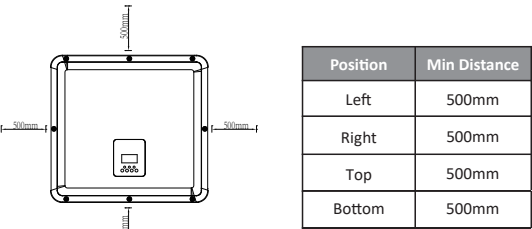

Step2: Mark the position

Installation position recommendation. Use a spirit level to adjust the installation position.

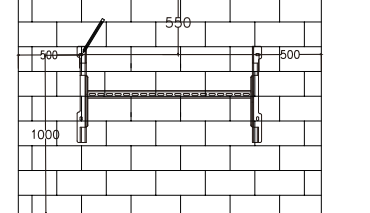

Step3: Drill the 6 holes with a φ8 drill bit.

Depth: at least 50mm Hammer the expansion tubes

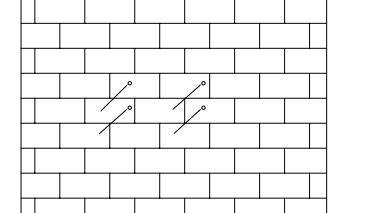

Installing the Bracket Screw the expansion bolts

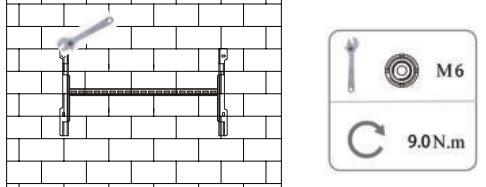

Step4: Match the inverter with bracket

Lock the screws on the side Make sure the inverter is firmly attached

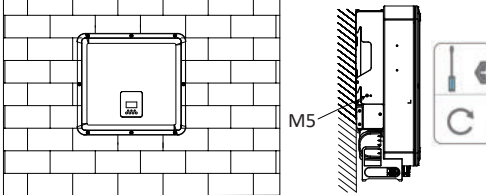

3. DC Connection

PV Connection

Choose 4mm<sup>2</sup> wire to connect the PV

Prepare AC wire as shown



PV+uses such terminals

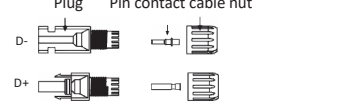

Press the wire and terminal tightly with a wire clamp

Insert pin into the male or female plug.

Until hear a "click"

Tighten the nut on the terminal

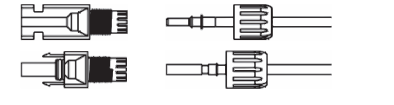

BAT Connection

BAT cable is in the BMS package and is recommended

Connect the BAT of the inverter and the battery port of the BMS with a power cable

Communication with BMS, BMS communication line needs to be shorter than 10m Assemble the gland and screw the nut.

Min. operating voltage of the BAT is 120V

Unlock the DC connector:

Use the specified wrench tool.

When separating the DC+ connector, push the tool down from the top.

When separating the DC- connector, push the tool down from the bottom.

Separate the connectors by hand.

Battery Wiring

Turn off the DC switch.

Choose 10mm<sup>2</sup> wire to connect the battery.

Trim 6mm of insulation from the wire end.

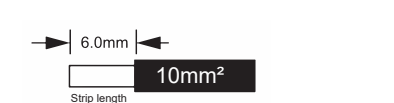

Separate the DC connector (battery) as below.

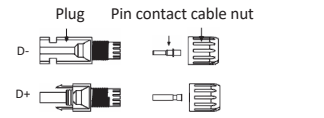

Insert striped cable into pin contact and ensure all conductor strands are captured in the pin contact.

Crimp pin contact by using a crimping plier. Put the pin contact with striped cable into the corresponding crimping pliers and crimp the contact.

Insert pin contact through the cable nut to assemble into back of the male or female plug. When you feel or hear a "click" the pin contact assembly is seated correctly.

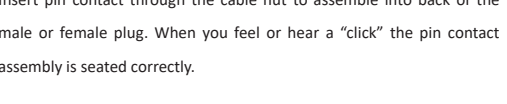

Note:

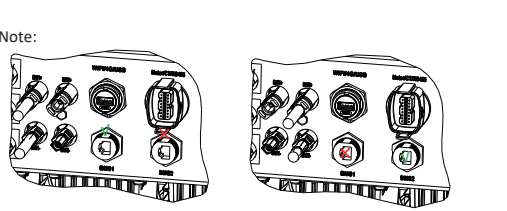

Unlock the DC connector:

Use the specified wrench tool.

When separating the DC+ connector, push the tool down from the top.

When separating the DC- connector, push the tool down from the bottom.

Separate the connectors by hand.

AC Connection

Step1: Cable dimensions

Modell (kW)	10.0	12.0	15.0	20.0	24.9-25.0	29.9-30.0
Cable (ON-GRID)	6.0-10.0mm <sup>2</sup>	6.0-10.0mm <sup>2</sup>	6.0-10.0mm <sup>2</sup>	10.0-16.0mm <sup>2</sup>	10.0-16.0mm <sup>2</sup>	10.0-16.0mm <sup>2</sup>
Micro-Breaker	40A	40A	50A	63A	63A	80A
Modell (kW)	10.0	12.0	15.0	20.0	24.9-25.0	29.9-30.0
Cable (EPS)	6.0-10.0mm <sup>2</sup>	6.0-10.0mm <sup>2</sup>	6.0-10.0mm <sup>2</sup>	10mm <sup>2</sup>	10.0mm <sup>2</sup>	10.0mm <sup>2</sup>
Micro-Breaker	40A	40A	50A	63A	63A	80A

Step2: Prepare AC wire as shown in the picture

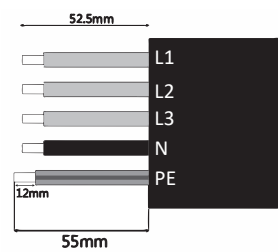

L1/L2/L3: Brown/Red/Green or Yellow Wire

N: Blue/Black Wire

PE: Yellow & Green Wire

Note: Please refer to local cable type and color for actual installation.

A. EPS Connection

Disassemble the connector

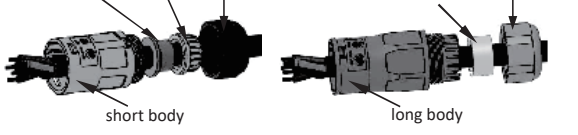

Tighten the wire with a screwdriver

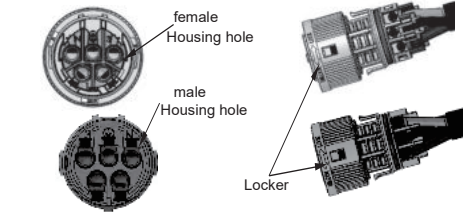

Push Housing into Body. Hear a click Tighten the nut on the terminal

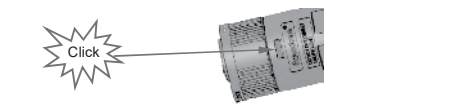

Put the sealing body and yarn trapper into the main body, screw the lock nut into the main body, and the torque is (2.5 +/- 0.5N.m).

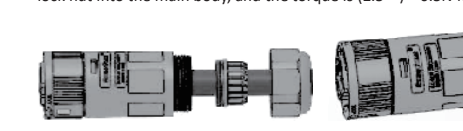

Insert the male end into the female end. For the rotation direction of the lock, please refer to the LOCK mark on the assembly.



Insert the connector onto the EPS rotate it to lock it



# H3 PRO QUICK INSTALLATION GUIDE

B. GRID Wiring

Separate the ON-GRID plug into three parts as below.

1. Hold the middle part of the female insert, rotate the back shell to loosen it, and detach it from female inset.

2. Remove the cable nut (with rubber insert) from the back shell.



Slide the cable nut and then the back shell onto the cable.

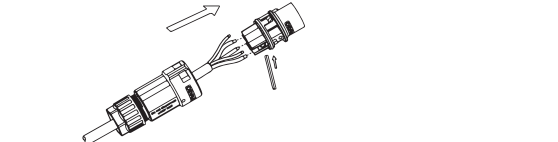

Push the threaded sleeve into the socket, tighten up the cap on the terminal and the torque is (4-5N.m).

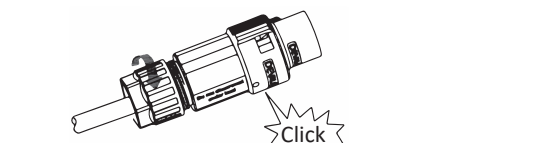

Push the threaded sleeve to connection terminal until both are locked tightly on the inverter

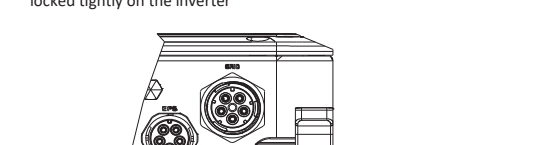

Remove the GRID connector: Press the bayonet out of the slot with a small screwdriver or the unlock tool and pull it out, or unscrew the threaded sleeve, then pull it out.

Insert striped cable into earth terminal and ensure all conductor strands are captured in the earth terminal.

Crimp earth terminal by using a crimping plier. Put the earth terminal with striped cable into the corresponding crimping pliers and crimp the contact.

Use the crimping pliers to press the ground cable into the ground terminal, screw the ground screw with screwdriver as shown below.



Grounding Wiring

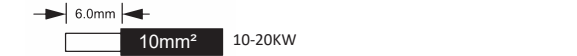

Trim 6mm of insulation from the wire end.

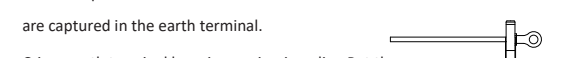

Use the crimping pliers to press the ground cable into the ground terminal, screw the ground screw with screwdriver as shown below.

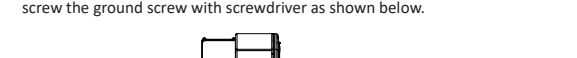
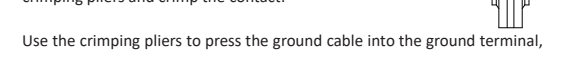

4. Serial Port Connections

Meter and RS485 should be connected to inverter by the connector illustrated in the figure below. All ports in connector should connect to the corresponding ports on inverter

METER/CT/RS485 interface (20pin terminals)

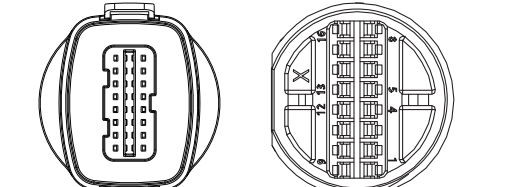

METER/CT/RS485 interface (20pin terminals)

1	2	3	4	5	6	7	8
DRY RLY2-	DRY RLY2+	DRY RLY1-	DRY RLY1+	/	/	Meter 485+	Meter 485-
9	10	11	12	13	14	15	16
GND TVS	GND COM	+12V SELV	RY Ctrl	/	/	/	/
17	18	19	20				
EMS 485A	EMS 485B	/	/				

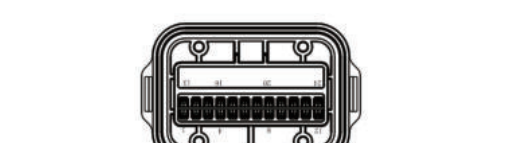
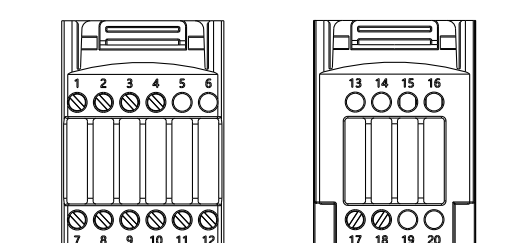

COM interface (24pin terminals)

1	2	3	4	5	6	7	8
/	/	/	/	/	ARM 485-	ARM 485+	GND COM
9	10	11	12	13	14	15	16
E STOP	/	/	VCC	DRM1	DRM2	DRM3	DRM4
17	18	19	20				
DRM0	GND COM	GND COM	/				

RJ45\_1 (24pin terminals)

1	2	3	4	5	6	7	8
CAN H1	CAN L1	CAN H2	CAN L2	485A	485B	GND COM	/

RJ45\_2 (24pin terminals)

1	2	3	4	5	6	7	8
CAN H1	CAN L1	CAN H2	CAN L2	485A	485B	GND COM	/

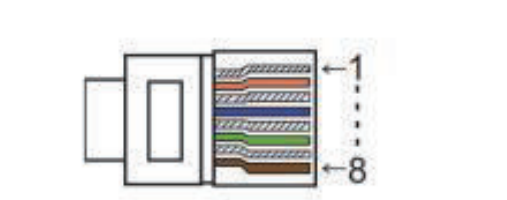
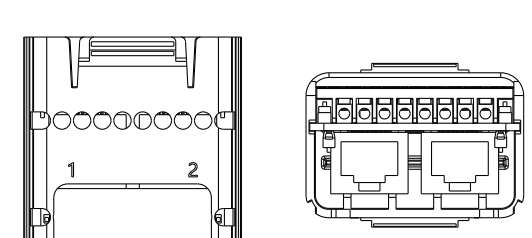
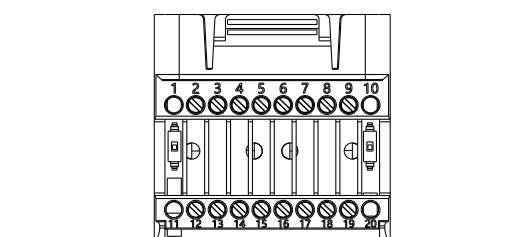

Note:

1. Compatible Meter type: DTSU666 (CHINT).

2. For other pin definitions, please refer to the user manual.

3. Communication A and B are marked on the side of the meter;

Local wiring colors are based on local codes, the quick release diagrams are for reference only.

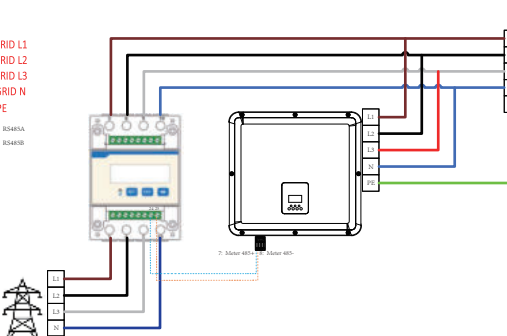

Note:

Local wiring colors are based on local codes, the quick release diagrams are for reference only.

5. Inverter Start-Up

Please refer to the following steps to start up the inverter.

1. Ensure the inverter fixed well.

2. Make sure all wirings are completed.

3. Make sure the meter is connected well.

4. Make sure the battery is connected well.

5. Make sure the AC-EP5 contactor is connected well (if needed).

6. Make sure the BMS buttons and battery switch are off.

7. Turn on the PV/DC switch (for Hybrid version only), AC-GRID breaker, EPS breaker and battery breaker.

8. If the main page shows "switch off", please long press "v" bottom to quickly go to the START/STOP page and set it to start. (Enter the settings page, default password is '0000').

Note:

Add boot-up guide interface, the first boot-up need to select the safety regulations and set the time.

Set the time on the inverter using the button or by using the APP.

6. Inverter Switch Off

Please refer to the following steps to switch off the inverter.

1. Enter the settings page, select START / STOP and set it to stop.

2. Turn off the PV/DC switch (for Hybrid version only), AC breaker, EPS breaker and battery breaker.

3. Wait 5 min before you open the upper lid (if in need of repair).

Note:

The inverter installation in complete. For battery installation, please refer to battery quick installation guide.

Please scan the QR Code and follow the steps below to download our latest multi-language User Manual/Quick Installation Guide:

Scan the QR Code → Select your Language → Choose to download User Manual or Quick Installation Guide → Download

Scan the QR Code → Select your Language → Choose to download User Manual or Quick Installation Guide → Download

Scan the QR Code → Select your Language → Choose to download User Manual or Quick Installation Guide → Download

Scan the QR Code → Select your Language → Choose to download User Manual or Quick Installation Guide → Download

Scan the QR Code → Select your Language → Choose to download User Manual or Quick Installation Guide → Download

Scan the QR Code → Select your Language → Choose to download User Manual or Quick Installation Guide → Download

Scan the QR Code → Select your Language → Choose to download User Manual or Quick Installation Guide → Download

Scan the QR Code → Select your Language → Choose to download User Manual or Quick Installation Guide → Download

Scan the QR Code → Select your Language → Choose to download User Manual or Quick Installation Guide → Download

Scan the QR Code → Select your Language → Choose to download User Manual or Quick Installation Guide → Download

Scan the QR Code → Select your Language → Choose to download User Manual or Quick Installation Guide → Download

Scan the QR Code → Select your Language → Choose to download User Manual or Quick Installation Guide → Download

Scan the QR Code → Select your Language → Choose to download User Manual or Quick Installation Guide → Download

Scan the QR Code → Select your Language → Choose to download User Manual or Quick Installation Guide → Download

Scan the QR Code → Select your Language → Choose to download User Manual or Quick Installation Guide → Download

Scan the QR Code → Select your Language → Choose to download User Manual or Quick Installation Guide → Download

Scan the QR Code → Select your Language → Choose to download User Manual or Quick Installation Guide → Download

Scan the QR Code → Select your Language → Choose to download User Manual or Quick Installation Guide → Download

Scan the QR Code → Select your Language → Choose to download User Manual or Quick Installation Guide → Download

Scan the QR Code → Select your Language → Choose to download User Manual or Quick Installation Guide → Download

Scan the QR Code → Select your Language → Choose to download User Manual or Quick Installation Guide → Download

Scan the QR Code → Select your Language → Choose to download User Manual or Quick Installation Guide → Download

Scan the QR Code → Select your Language → Choose to download User Manual or Quick Installation Guide → Download

Scan the QR Code → Select your Language → Choose to download User Manual or Quick Installation Guide → Download

Scan the QR Code → Select your Language → Choose to download User Manual or Quick Installation Guide → Download